



## THE SPECIALISTS.

Our functional doors for all cases

**Performance promise and service standards**

Design | Security | Service Pages 04 - 11

**Security doors****Burglar-resistant security doors**

dw 42-1 "Teckentrup" (WK 2) **Pages 14 - 15**  
 dw 62-1 "Teckentrup" (RC 2 - RC 4) Pages 16 - 17  
 dw 62-1 "Teckentrup" (RC 2 - RC 3) Thick rebate Pages 18 - 19  
 Bullet-proof door Pages 20 - 21  
 Prison cell door Pages 22 - 23  
Pages 24 - 25

**Sound-insulating doors****Sound insulating-doors**

dw 67-1/S "Teckentrup" (up to 53 dB) **Pages 26 - 27**  
 dw 67-1/2/HS "Teckentrup" (up to 57 dB) Pages 28 - 29  
Pages 30 - 31

**Multi-purpose doors****Multi-purpose doors**

dw 62-1 "Teckentrup" iso+ ( $U_D=0,89$ ) **Pages 32 - 33**  
 MZD-HT8 "Teckentrup" Pages 34 - 35  
 dw 42-1/2 "Teckentrup" Pages 36 - 37  
 dw 62-1/2 "Teckentrup"/+"XL" Pages 38 - 39  
 dw 62-1/2 "Teckentrup"/+"XL" Thick rebate Pages 40 - 41  
 "Teckentrup" 62 SR3 - LPS 1175 Pages 42 - 43  
 Swing door Pages 44 - 45  
 Stainless steel door "Water" Pages 46 - 47  
Pages 48 - 49

**Internal doors****Internal doors**

Internal door "Teckentrup" **Pages 50 - 51**  
 Internal door "Object" Pages 52 - 53  
Pages 54 - 55

**Design variety**

Colours, stainless steel, glazings, handle-sets Pages 56 - 63

**Safety aspects**

Safety, accessories, door closer Pages 64 - 73  
 Frames Pages 74 - 81  
 Technical data Pages 82 - 83

MADE  
IN  
GERMANY



# TECKENTRUP DOOR SOLUTIONS

Whether it's development, production or distribution, whether it's about the entire whole or about a small detail, for us, everything revolves around the decisive question: **WHAT IS THE SOLUTION FOR YOU?**

Because we are the specialist for fire protection, smoke protection, sound insulation and security doors, for industrial sectional doors, rolling shutters, folding doors, sliding doors and garage doors.

And we are **"Made in Germany"**. For more than 80 years, we have developed and produced our products exclusively in Germany. More than 900 employees at our locations in Verl and Großzöberitz create our high-quality products for you. All processes, from supply to production to commissioning and delivery, are based on the DIN EN ISO 9001 quality management system.

DESIGN

SECURITY

SERVICE

Teckentrup produces more than doors and gates: Teckentrup delivers solutions. Which is why we have applied three new standards to our company and our products which meet your needs: Design. Security. Service.

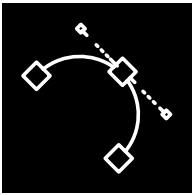

**Design:** We link functionality and aesthetics.

Because good design represents innovative technology that meets the needs of the user. Our products are opening new worlds and offer many individual design options. With us, designers and engineers work hand-in-hand from the beginning. So that intelligent ideas are just as convincing at the second glance and sophisticated designs prove themselves day after day.



**Security:** We link systems to protection.

Our doors meet the highest requirements and are certified accordingly. We are happy to advise you on necessary standards and develop comprehensive needs-oriented safety approaches in order to protect people and valuables.

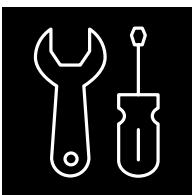

**Service:** We link speed to reliability.

Proximity, clear structures, everything from one source. This is the service advantage of Teckentrup. Because, from product development to installation, from the committed support of our expert advisers to professional servicing: we will be there for you right away. We are happy to make the time.





# BUILDING EXPERTISE FROM ONE SOURCE

Large construction projects are faced with enormous cost pressure. This is why all of our products are embedded in an approach for process optimisation. We count on holistic service – from planning to installation to operating our folding doors. We can support you with consultation and planning services, we provide just-in-time deliveries if required, we place great emphasis on easy installation and we are also there to help you at any time during the construction phase by providing solutions at short notice. Therefore, you can rest assured that you receive the right solution for all of your property's requirements.

---

## OUR SERVICES FOR YOU

Secure clear efficiency advantages for yourself in every project phase:

- Comprehensive property and project advising for each of your projects
- Standardised technological platform with sophisticated installation materials
- Tender documents and technical drawings to develop your tender

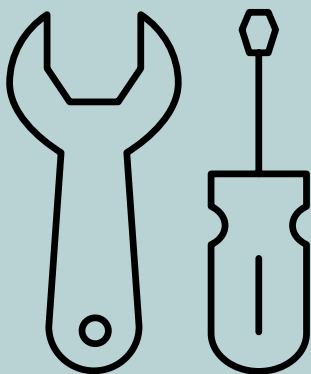

More information at [www.teckentrup.biz](http://www.teckentrup.biz)

# PROFESSIONAL PRODUCTS IN EVERY DETAIL

**You will know the situation as a professional project manager: Whether the project turns out to be a great success often depends on minute details. Got to know that you can rely on our comprehensively designed door solutions. For instance, when it comes to accessories, components and supplemental modules.**

In serial production at Teckentrup: Extra advise ex works: Whether it is door handles, lock and escape route technology, hinges and security bolts, door closers or electronic attachments - our employees are happy to support you select and configure the optimal components at any time. It goes without saying that this also applies for the selection of the colours, surfaces and glazing. The result: a comprehensive systematic solution for your project in which all pieces perfectly fit.





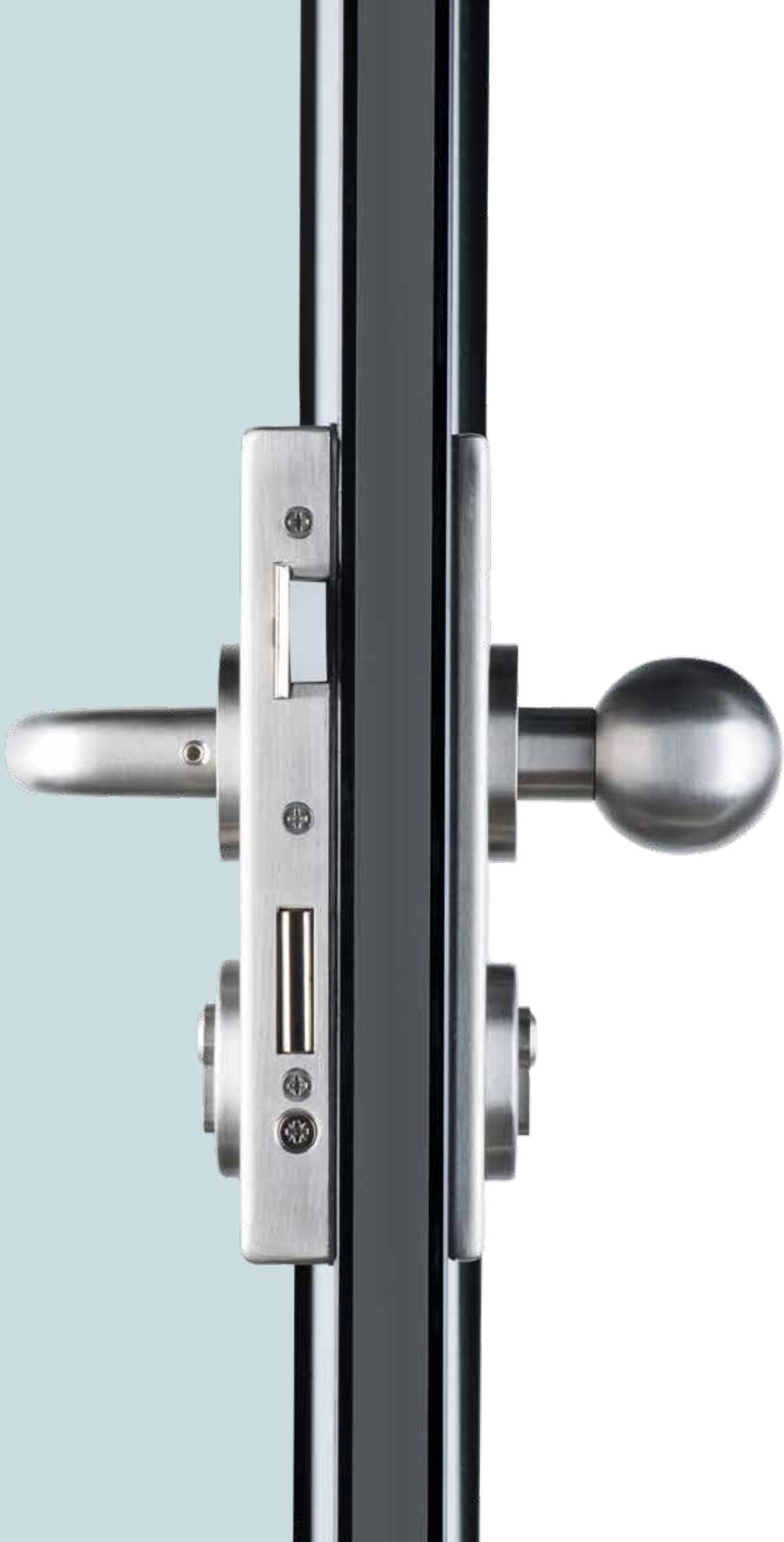

# COMPREHENSIVE SERVICE

We provide custom solutions and comprehensive service to our customers, from project planning to installation to operating our products. Take a look for yourself.

## RADISSON RED CAPE TOWN, SOUTH AFRICA



Under the Radisson Red label, the Ressor Gropu is developing a new hotel type: discerning 4-star level with a fresh interior. One of the first of these hotels has now been opened in Cape Town, the exciting port metropolis at the foot of Table Mountain on the Southwest tip of Africa. The spectacular port facility in the urban district of the old granary has the downside of a lot of noise, both at day and night. For that reason, sound proofing plays a particularly key role, meaning that Teckentrup doors with a high degree of sound insulation of 45 dB, for instance, ensure quiet rooms despite the noisy surroundings.

With a total volume of 567 doors, however, other criteria such as fire and smoke protection are also important. The T30-1/2 FSA 62, T60-2 FSA 62, dw 42-1/2, dw 62-2 series, swing doors and internal doors are therefore installed in the Radisson Red. Practical benefits such as height adjustment, which makes installation quick and easy, were further factors when choosing the doors.





## AHAUS POLICE STATION

Very robust against “mechanical impacts”, quick to lock, with a hatch and the option of looking into the entire cell from the outside - the requirements profile for a cell door is rather complex. The police station in Ahaus (North Rhine-Westphalia) shows how such high requirements are fulfilled. Since the summer of 2014, the 40,000-head municipality of Ahus on the German/Netherlands border has had a new police station.

The three-storey clinker construction is not only headquarters but also prison cells, and therefore rooms that mean unusual demands on doors: First, the construction elements have to be particularly robust. For that reason, the fitting technology, for instance, is made of robust stainless steel. As protection from the sudden opening of the door, a protection chain is used, and a quick-action lock with a sliding bolt is included in the equipment.

It is also important to be able to look into the cell. Instead of the cumbersome video technology, a spy hole is integrated in the door leaf in Ahaus to this end. The guards therefore have a 175-degree view of the cells. For the cases in which the door is not to be opened at all and the imprisoned person nevertheless needs to be looked after, the “communication hatch” is intended.

# QUICK AND EASY QUOTATION

## Teckentrup. Easy. Online.

TEO, our configuration tool for doors and gates, helps you to create a quotation and provides you with the option of configuring different doors and gates online and visualising them for your customers.

Plausibility check

Sound insulation

Fire protection

Security





## Configure products easily online

---

**Our promise: A quotation in 5 minutes!**

---



### **Quick and secure consultation**

Avoids configuration errors thanks to the automatic plausibility check in the background.



### **Comprehensive technical documentation**

Current technical documentation for the product with just one click.



### **Individual quotation**

Send a quotation with your logo and contact data directly.



### **Efficient quotation management**

Save, reuse and revise quotations easily.



### **Secure system**

Access control secures personal data. System safeguards comply with the legal data protection regulations.

TEO is available at the following link:

**[teo.teckentrup.biz](https://teo.teckentrup.biz)**



# THE BASTION TECKENTRUP SECURITY DOORS

At first sight, they seem rather innocuous. But when push comes to shove, they perform. And even resist armed assailants. This makes our security doors suitable for all risk areas. Our prison cell doors and bullet-proof doors top off our range in the area of danger protection.

## Uses

- Security rooms in airports and railway stations
- Police stations
- Banks, savings banks
- Justice buildings
- Police sections in larger arenas
- Private buildings with stringent security requirements





Burglary-resistant  
in accordance with  
ENV 1627/EN 1627





# STEEL SECURITY DOOR

## DW 42-1 "TECKENTRUP" (WK 2)

- 1-LEAF
- THICK REBATE

### Size range

Modular dimensions:

Width: 625 – 1250 mm

Height: 1750 – 2250 mm

### Installation in

- Masonry, min. 115 mm
- Concrete, min. 100 mm
- Autoclaved aerated concrete, min. 150 mm

### Door leaf

- Double-skinned
- 3-leaf rebated
- Door leaf thickness: 42 mm
- Panel thickness: 1.0 / 1.5 mm

### Surface

Door leaf and frame galvanised and powder coated primed; grey white like RAL 9002

### Frame

- Corner frame, 2.0 mm thick with 3-leaf seal and lower floor bracket
- Frame attached with exposed masonry installation

### Special frame equipment

Counter frame, U frame or block frame

### Special equipment

- RAL of your choice
- Handle/change fittings
- Locks
- Top door closer EN 1154
- Broad angle door spy
- Lock control (bolt contact installed)
- Escape door openers
- Alarm wire insert
- Security chains (can also be locked)
- Rain canopy/rain guard

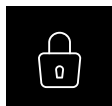

**Burglary-resistant**  
according to DIN  
ENV 1627, WK 2<sup>2)</sup>



**Fire-resistant**  
as per EN 1634-1/  
DIN 4102



**Sound-insulated**  
EN ISO 10140/  
EN ISO 717-1  
up to Rw 37 dB<sup>1)</sup>



**Use in outdoor walls**  
CE labelling as per  
EN 14351-1

**TECKENTRUP**  
DOOR SOLUTIONS





# STEEL SECURITY DOOR

## DW 62-1/2 "TECKENTRUP" (RC 2/RC 3/RC 4)

- 1-LEAF OR 2-leafs
- THIN REBATE
- ALSO IN STAINLESS STEEL
- OPTIONALLY WITH GLAZING
- OPTIONALLY WITH STEEL TRANSFORMER GRILLE

### Size range

Modular dimensions, 1-leaf (as flap)

Width: 500 – 1250 mm  
Height: 500 – 1749 mm

Modular dimensions, 1-leaf:

Width: 625 – 1500 mm  
Height: 1750 – 3000 mm

Modular dimensions, 2-leafs:

Width: 1375 – 3000 mm  
Height: 1750 – 3000 mm

### Installation in

- RC 2-4: Masonry, min. 115 mm
- RC 2-4: Concrete, min. 100 mm
- RC 2-3: Lightweight partition<sup>2)</sup>
- RC 2-3: Autoclaved aerated concrete, min. 170 mm

### Door leaf

- Double-skinned
- 3-leaf rebated
- Door leaf thickness: 62 mm
- Panel thickness: 1.0/1.5 mm

### Surface

Door leaf and frame galvanised and powder coated primed; grey white like RAL 9002

### Frame

- Corner frame, 1.5 mm thick with 3-leaf seal and lower floor bracket
- Frame attached with exposed masonry installation

### Special frame equipment

Counter frame, U frame or block frame

### Glazing

Burglar-resistant category in accordance with DIN EN 356-P4A (RC 2), 356-P6B (RC 3), 356-P6B (RC 4)

### Special equipment

- RAL of your choice
- Handle/change fittings
- Locks
- Top door closer EN 1154
- Broad angle door spy
- Lock control (bolt contact installed)
- Escape door openers
- Alarm wire insert
- Security chains (can also be locked)
- Transformer grille
- Rain canopy/rain guard
- Optional with design profile FB

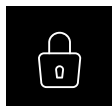

**Burglary-resistant**  
according to DIN  
EN 1627 RC 2/ RC 3/  
RC 4<sup>1)</sup>



**Sound-insulated**  
EN ISO 10140/  
EN ISO 717-1  
up to Rw 42 dB<sup>1)</sup>



**ATEX**  
Directive  
2014/34/EU<sup>1)</sup>

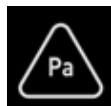

**Pressure resistance**  
as per EN 12210<sup>1)</sup>



**Use in outdoor walls**  
CE labelling as per  
EN 14351-1

**TECKENTRUP**  
DOOR SOLUTIONS



# STEEL SECURITY DOOR

## DW 62-1/2 "TECKENTRUP" DF (RC 2/RC 3)

- 1-LEAF OR 2-leafs
- THICK REBATE
- ALSO IN STAINLESS STEEL
- OPTIONALLY WITH GLAZING
- OPTIONALLY WITH STEEL TRANSFORMER GRILLE

### Size range

Modular dimensions, 1-leaf (as flap)

Width: 500 – 1250 mm  
Height: 500 – 1749 mm

Modular dimensions, 1-leaf:

Width: 750 – 1500 mm  
Height: 1750 – 3000 mm

Modular dimensions, 2-leafs:

Width: 1375 – 3000 mm  
Height: 1750 – 3000 mm

### Installation in

- Masonry, min. 115 mm
- Concrete, min. 100 mm
- Lightweight partition<sup>2)</sup>
- Autoclaved aerated concrete, min. 170 mm

### Door leaf

- Thick rebate
- 3-leaf rebated
- Door leaf thickness: 62 mm
- Panel thickness: 1.0 /1.5 mm

### Surface

Door leaf and frame galvanised and powder coated primed; grey white like RAL 9002

### Frame

- Corner frame , 1.5 mm thick with 3-leaf seal and lower floor bracket
- Frame attached with exposed masonry installation

### Special frame equipment

Counter frame, U frame or block frame

### Glazing

Burglar-resistant category in accordance with DIN EN 356-P4A (RC 2), 356-P6B (RC 3)

### Special equipment

- RAL of your choice
- Handle/change fittings
- Locks
- Top door closer EN 1154
- Broad angle door spy
- Lock control (bolt contact installed)
- Escape door openers
- Alarm wire insert
- Security chains (can also be locked)
- Transformer grille
- Rain canopy/rain guard
- Optional with design profile FB

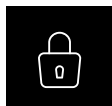

**Burglary-resistant**  
according to DIN  
EN 1627 RC 2/ RC 3<sup>1)</sup>



**Sound-insulated**  
EN ISO 10140/  
EN ISO 717-1  
up to Rw 42 dB<sup>1)</sup>



**ATEX**  
Directive  
2014/34/EU<sup>1)</sup>



**Use in outdoor walls**  
CE labelling as per  
EN 14351-1

**TECKENTRUP**  
DOOR SOLUTIONS



Prevents a bullet penetration the object. Its solid 64 mm door leaf has special armour and thereby reaches the bullet-proof effect of category FB 4 for handguns (e.g. 44 Magnum). Optionally, you can use the door with glazing (according to DIN EN 1063 – BR 4). The verification contains the addition NS = splinter-free, i.e. no splinters penetrate.

# BULLET-PROOF STEEL DOOR

## DW 64-1 "TECKENTRUP BP" CLASS FB4

- 1-LEAF
- THIN REBATE
- VERIFIED IN ACCORDANCE WITH DIN EN 1522 CLASS FB4 NS
- OPTIONAL WITH GLAZING

### Size range

Modular dimensions:

Width: 750 – 1500 mm  
Height: 1750 – 3000 mm

### Installation in

- Masonry, min. 240 mm
- Concrete, min. 140 mm

### Door leaf

- Double-skinned, rebated on 3 sides,
- Filling: Steel plate, mineral wool, gypsum cardboard
- Door leaf thickness: 64 mm
- Panel thickness: 1.5 mm

### Surface

Door leaf and frame galvanised and powder coated primed; grey white like RAL 9002

### Frame

- Corner frame 2.0 mm thick with 3-leaf seal and lower floor bracket
- With bottom stop bar
- Frame attached with screw installation, quantity: 3 pieces per side

### Special frame equipment

Counter frame, U frame or block frame

### Special equipment

- Handle/change fittings (various models) with fixed head on the outside
- Locks
- Panic locks
- Multiple locking device
- Bottom seals
- Rectangular glazing (special size)
- Aluminium rain guard
- With retractable bottom seal
- With glazing according to DIN EN 1063 - BR 4 (NS = inside splinter-free)



**Burglary-resistant**  
according to DIN  
EN 1627, (RC 4)<sup>1)</sup>



**Fire-resistant**  
according to EN 1634-1  
(DIN 4102)<sup>1)</sup>



**Sound-insulated**  
EN ISO 10140/  
EN ISO 717-1  
up to Rw 45 dB<sup>1)</sup>



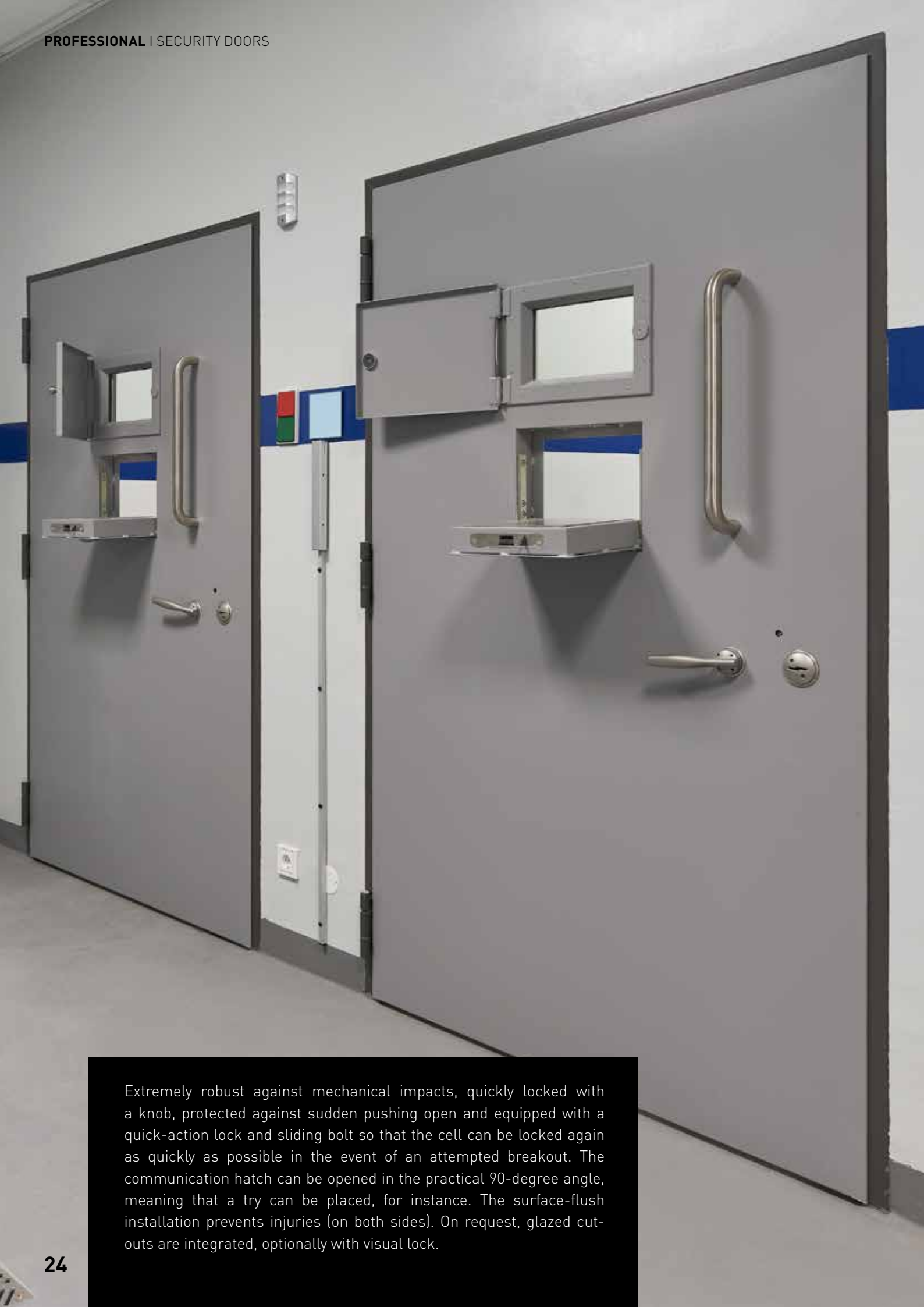

Extremely robust against mechanical impacts, quickly locked with a knob, protected against sudden pushing open and equipped with a quick-action lock and sliding bolt so that the cell can be locked again as quickly as possible in the event of an attempted breakout. The communication hatch can be opened in the practical 90-degree angle, meaning that a try can be placed, for instance. The surface-flush installation prevents injuries (on both sides). On request, glazed cut-outs are integrated, optionally with visual lock.

# CELL ROOM STEEL DOOR

## “TECKENTRUP” (TYPE A, B, B + T15)

- 1-LEAF
- THIN REBATE
- TYPE A VERIFIED ACCORDING TO RC 3
- TYPE B VERIFIED ACCORDING TO RC 4
- TYPE B + T15 VERIFIED ACCORDING TO RC 4 ND 15-MINUTE UNLOCKING CAPACITY FOR FIRE IMPACT

### Size range

Modular dimensions type A / type B:

Width: 750 – 1500 mm  
Height: 1750 – 2500 mm

Modular dimensions type B+T15:

Width: 750 – 1250 mm  
Height: 1750 – 2250 mm

### Installation in

- Masonry
- Concrete

### Door leaf

- Double-skinned, 3-side rebated without bottom buffer or 4-side rebated with bottom buffer, rebate width at least 20 mm
- Door leaf thickness: 64 mm with anti-drumming coating<sup>1)</sup>
- Panel thickness: 1.5 mm, on the cell side 2.0 mm thick, directed steel panel
- 2 solid, galvanised security bolts on the hinge side

### Surface

Door leaf and frame galvanised and powder coated primed; grey white like RAL 9002

### Frame

- Corner frame made from galvanized plate, prepared with buffer dampener for 3-side circumferential frame seal, without floor recess with transport traverse
- Standard frame fastening by masonry anchor

### Special frame equipment

- Block frame type 1.1 or 2.1/2.2 optionally with frame seal

### Special equipment

- Stainless steel handle (length 500 mm)
- Broad angle door spy with swivelling cover sheet
- Rotary door spy (broad angle/pill hatches/closed)
- Special door spies on request
- Additional bolt lock at the top and/or bottom
- Inside sliding bolt made from flat steel 30x10 mm, with steel actuation handle (not in combi with drive bolt lock)
- Prepared for cell lock with drive bolt lock
- Prepared for cell room lock with electric control (cable transition)
- Top door closer
- 3. Door hinge central
- Door stopper
- Stainless steel door knob on round rosette
- Cell locks



**Burglary-resistant**  
according to DIN  
EN 1627 RC 3/ RC 4<sup>1)</sup>

**TECKENTRUP**  
DOOR SOLUTIONS





Sound-insulated in  
accordance with DIN EN  
10140/717-1

# THE CALMING ELEMENT TECKENTRUP SOUND- INSULATING DOORS

**On the side hectic office day-to-day, on the other side wonderful calmness. For everyone wanting to concentrate, have a one-on-one discussion or just relax briefly.**

Noise and loud sounds in the workplace can have a hugely negative impact on the working environment, as well as on health, occupational safety, efficiency and concentration. Here, our sound-insulating doors provide effective help, in both directions: What this means is: For rooms with a lot of noise, it is ensured that the noise cannot reach outside. And in residential and office buildings, the inside areas are sealed from noise from the outside.

Teckentrup sound-insulated door can be used inside and outside. They are designed in such a way that optimal sound proofing is achieved with special seals. Depending on the configuration, Teckentrup sound-insulating doors tested in accordance with DIN EN 10140/717-1 achieve excellent sound insulation values of up to 57 dB.

## Uses

- All other industrial areas
- Commercial premises
- Event spaces
- Conference rooms
- Public buildings
- Residential housing





# SOUND-INSULATED STEEL DOOR

## DW 67-1/S "TECKENTRUP" DF (UP TO RW 53 DB)

- 1-LEAF
- THICK REBATE
- SOUND INSULATED UP TO RW 53 DB\*

### Size range

Modular dimensions:

Width: 750 – 1500 mm

Height: 1750 – 3000 mm

\*The sound insulation value refers to a max. BRM height of 2,500 mm

### Installation in

Sound insulation measurement of the wall = sound insulation measurement of the door + > 10dB

### Door leaf

- Thick rebate, with 3-side rebate seal
- Door leaf thickness: 67 mm
- Panel thickness: 1.5 mm
- With double retractable floor seal:  
Rw 50 dB with double slide threshold and floor profile: Rw 53 dB (frame with floor recess mandatory)

### Surface

Door leaf and frame galvanised and primed; grey white like RAL 9002

### Frame

- Corner frame 2.0 mm thick with 3-leaf seal
- On-site grouting required

### Special frame equipment

Counter frame, U frame or block frame

### Special equipment

- RAL of your choice
- Door closers
- Fastening unit for exposed masonry
- Anti-panic function EN 179/EN 1125

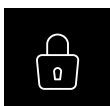

**Burglary-resistant**  
according to  
DIN EN 1627,  
RC 2<sup>1)</sup>



**Sound-insulated**  
EN ISO 10140/  
EN ISO 717-1  
up to Rw 53 dB<sup>1)</sup>



**ATEX**  
Directive  
2014/34/EU<sup>1)</sup>

**TECKENTRUP**  
DOOR SOLUTIONS



# SOUND-INSULATED STEEL DOOR

## DW 67-1/2 HS "TECKENTRUP" DF (UP TO RW 57 DB)

- 1-LEAF OR 2-LEAFS
- THICK REBATE
- HIGH SOUND INSULATED UP TO RW 57 DB\*
- ALSO PERMITTED FOR ESCAPE ROUTES AND EMERGENCY EXISTS!

### Size range

Modular dimensions, 1-leaf:

Width: 750 – 1500 mm

Height: 1750 – 3000 mm

Modular dimensions, 2-leaves:

Width: 1375 – 3000 mm

Height: 1750 – 3000 mm

\*The sound insulation value refers to a max. measure of 2500 x 2500 mm.

### Surface

Door leaf and frame galvanised and primed; grey white like RAL 9002

### Frame

- Corner frame 2.0 mm thick with 3-leaf seal
- On-site grouting required

### Special equipment

- RAL of your choice
- Door closers
- Fastening unit for exposed masonry
- Anti-panic function EN 179/EN 1125 (1-leaf)

### Installation in

Sound insulation measurement of the wall = sound insulation measurement of the door +  $\geq 10$ dB

### Special frame equipment

Counter frame, U frame

### Door leaf

- Thick rebate, with 3-side rebate seal
- Door leaf thickness: 67 mm
- Panel thickness: 1.5 mm
- With double retractable floor seal:  
1-leaf/2-leaves = Rw 55 dB with double slide threshold and floor profile:  
Single-leaf = Rw 57 dB



**Burglary-resistant**  
according to  
DIN EN 1627,  
RC 2<sup>11</sup>



**Sound-insulated**  
EN ISO 10140/  
EN ISO 717-1  
up to Rw 57 dB<sup>11</sup>



**ATEX**  
Directive  
2014/34/EU<sup>11</sup>

**TECKENTRUP**  
DOOR SOLUTIONS

# THE ALL-ROUNDERS TECKENTRUP MULTI-PURPOSE DOORS

**They do exactly what they want in any situation. Be it in day-to-day tasks, such as protection against fire, burglary and noise, for special requirements in the technical area or under special hygienic conditions.**

The term multi-purpose doors designates traditional single- or double-leaf steel doors for internal or external walls. If additional specifications such as anti-burglary protection or sound insulation are required, we speak about multi-functional doors that provide multiple forms of protection. In particular for outside doors, heat protection plays a key role, of course. As regards the equipment possibilities, there are virtually no limits for our multi-purpose doors: Various panel thicknesses, glazings, ventilation and transformer grilles, fixtures made from plastics, aluminium or stainless steel - through to doors in XL format... we make it happen!

## Uses

- All other industrial areas
- Commercial premises
- Event spaces
- Conference rooms
- Public buildings
- Residential housing







The iso+ is suitable as an outside door for all areas of the energy modernisation methods within the private and commercial sectors, but also for the planning of new builds cording to the latest EnEV. In comparison to conventional multi-purpose doors it improves thermal insulation by up to 40%. Thanks to additional sound insulation (max. 38 dB), the door still achieves the outstanding  $U_D$  value of  $1,0W/(m^2 \cdot k)$ .

iso+ is optionally available in a burglar-resistant RC 2 version. The door fulfils the specifications of DIN EN 14351-1 and is labelled with the CE mark as per building product guidelines for external doors.



# THERMALLY SEPARATED STEEL DOOR

## DW 62-1 "TECKENTRUP ISO+" DF

- 1-LEAF
- THICK REBATE
- HEAT INSULATION WITH PU FOAM:  $U_D = 0,89 \text{ W}/(\text{M}^2\cdot\text{K})$ , WITH MINERAL WOOL:  $U_D = 1,0 \text{ W}/(\text{M}^2\cdot\text{K})$

### Size range

Modular dimensions:

Width: 625 – 1250 mm

Height: 1750 – 2350 mm

### Door leaf

- Thick rebate, 3 sides rebated
- Door leaf thickness: 62 mm
- Panel thickness: 1.0 mm
- Hinge and opposite hinge side thermally insulated,
- With retractable floor seal
- Insulation: PU filling; mineral wool
- 3D hinges galvanised

### Surface

Door leaf and frame galvanised and primed; grey white like RAL 9002

### Frame

- Corner frame 1.5 mm thick with 3-leaf seal and lower floor bracket
- Frame attached with exposed masonry installation
- With thermal separation

### Special frame equipment

Counter frame

### Special equipment

- RAL of your choice
- Handle/change fittings
- Panic locks
- 3-fold bolt locking system
- Top door closer as per DIN EN 1154
- Aluminium rain guard



Far smaller energy loss thanks to thermally separated door



Visible energy loss without thermally separated door

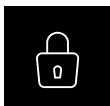

**Burglary-resistant**  
according to DIN EN 1627, RC2<sup>1)</sup>



**Sound-insulated**  
EN ISO 10140/  
EN ISO 717-1  
up to  $R_w$  38 dB<sup>1)</sup>



**ATEX**  
Directive  
2014/34/EU<sup>1)</sup>



**Use in outdoor walls**  
CE labelling as per  
EN 14351-1

**TECKENTRUP**  
DOOR SOLUTIONS



# MULTI-PURPOSE STEEL DOOR

## MZD-HT8 "TECKENTRUP"

- 1-LEAF
- THIN REBATE
- FOR LEFT/RIGHT HAND OPERATION
- HEAT INSULATION  $U_D = 1.5 \text{ W}/(\text{M}^2\cdot\text{K})^{[3]}$

### Size range

Modular dimensions:

Width: 750 – 1125 mm

Height: 1750 – 2125 mm

### Door leaf

- Thin rebate
- 4-leaf rebated
- Door leaf thickness: 42 mm
- Panel thickness: 0.9 - 1,0 mm

### Surface

Door leaf and frame galvanised and powder coated primed; grey white like RAL 9002

### Frame

- Corner frame 2.0 mm with 4-leaf seal, (sound-insulated). Designed such that the lower buffer can be removed.
- Frame attached with exposed masonry installation

### Special frame equipment

Counter frame

### Special equipment

- RAL of your choice
- Prepared for escutcheon hardware (State buffer type)
- Aluminium rain guard



**Sound-insulated**  
EN ISO 10140/  
EN ISO 717-1  
up to  $R_w$  39 dB<sup>1)</sup>



**Use in outdoor walls**  
CE labelling as per  
EN 14351-1

**TECKENTRUP**  
DOOR SOLUTIONS



# MULTI-PURPOSE STEEL DOOR

## DW 42-1/2 "TECKENTRUP"

- 1-LEAF OR 2-leafs
- THIN REBATE
- OPTIONALLY WITH GLAZING/UPPER CASING
- HEAT INSULATION 1-LEAF:  $U_D = 1.6 \text{ W}/(\text{M}^2\cdot\text{K})^{31}$  / 2-leafs:  $U_D = 1.8 \text{ W}/(\text{M}^2\cdot\text{K})^{31}$
- SOUND INSULATION WITH SPECIAL GLAZING UP TO 44 dB

### Size range

Modular dimensions, 1-leaf:

Width: 625 – 1250 mm  
Height: 1750 – 2250 mm

Modular dimensions, 2-leafs:

Width: 1375 – 2500 mm  
Height: 1750 – 2250 mm

### Door leaf

- Thin rebate, 3 sides rebated
- Door leaf thickness: 42 mm
- Panel thickness: 1.0/1.5 mm

### Surface

Door leaf and frame galvanised and powder coated primed; grey white like RAL 9002

### Frame

- Corner frame 2.0 mm thick galvanised with 3-leaf and lower floor bracket
- Frame attached with exposed masonry installation
- On-site grouting required

### Special frame equipment

Counter frame, U frame or block frame

### Glazing

- Glazing field rectangular with Aluminium glass retaining strip
- Round glazing
- Upper casing fully fixed
- Upper casing with glazing or panel filling

### Special equipment

- RAL of your choice
- With aluminium completion profile, with slide threshold, frame with raised sill
- With retractable bottom seal
- With stop rail, with seal (not permitted for escape routes and emergency exits)
- Insect protection grille
- Ventilation grille
- Handle fittings/profile cylinder
- Anti-panic locks and fixtures
- Door closers
- Arresting systems (with door closer system, adhesive magnet)
- Electrical equipment



**Sound-insulated**  
EN ISO 10140/  
EN ISO 717-1  
up to  $R_w$  37 dB<sup>31</sup>



**Use in outdoor walls**  
CE labelling as per  
EN 14351-1

**TECKENTRUP**  
DOOR SOLUTIONS







# MULTI-PURPOSE STEEL DOOR

## DW 62-1/2 "TECKENTRUP"/"TECKENTRUP XL"

- 1-LEAF OR 2-leafs
- THIN REBATE
- OPTIONALLY WITH GLAZING/UPPER CASING
- HEAT INSULATION 1-LEAF:  $U_D = 1.3 \text{ W}/(\text{M}^2 \cdot \text{K})^3$  / 2-leafs:  $U_D = 01.4 \text{ W}/(\text{M}^2 \cdot \text{K})^3$
- SOUND INSULATION WITH SPECIAL GLAZING UP TO 42 DB

### Size range

#### Modular dimensions, 1-leaf:

Width: 625 – 1500 mm

Height: 1750 – 3000 mm/4000 mm(XL)  
with upper casing (height): 4000 mm/  
5000 mm (XL)

#### Modular dimensions, 2-leafs:

Width: 1375 – 3000 mm

Height: 1750 – 3000 mm/4000 mm(XL)  
with upper casing (height):  
4000 mm/5000 mm (XL)

### Door leaf

- Thin rebate
- 3-leaf rebated
- Door leaf thickness: 62 mm
- Panel thickness: 1.0/1.5 mm (XL: 1.5 mm)

### Surface

Door leaf and frame galvanised and primed; grey white like RAL 9002

### Frame

- Corner frame 1.5 mm thick, galvanised ( $\geq 2500$  mm BRM height = corner frame 2.0 mm thickness)
- With 3-side seal and lower floor bracket
- Frame attached with exposed masonry installation

### Special frame equipment

Counter frame, U frame or block frame

### Glazing

- Glazing field rectangular with Aluminium glass retaining strip
- Round glazing
- Upper casing fully fixed
- Upper casing with glazing or panel filling

### Special equipment

- RAL of your choice
- Handle fittings/profile cylinder
- Anti-panic locks and fixtures
- Door closers
- Arresting systems (with door closer system, adhesive magnet, hinged door drive unit)
- Electrical equipment
- Optional with design profile FB



**Sound-insulated**  
EN ISO 10140/  
EN ISO 717-1  
up to Rw 42 dB<sup>1)</sup>



**ATEX**  
Directive  
2014/34/EU<sup>1)</sup>

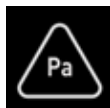

**Pressure resistance**  
as per EN 12210<sup>1)</sup>



**Use in outdoor walls**  
CE labelling as per  
EN 14351-1

**TECKENTRUP**  
DOOR SOLUTIONS



# MULTI-PURPOSE STEEL DOOR

## DW 62-1/2 "TECKENTRUP"/"TECKENTRUP XL" DF

- 1-LEAF OR 2-leafs
- THICK REBATE
- OPTIONALLY WITH GLAZING/UPPER CASING
- HEAT INSULATION 1-LEAF:  $U_D = 1.3 \text{ W}/(\text{M}^2 \cdot \text{K})^{31}$  / 2-leafs:  $U_D = 1.4 \text{ W}/(\text{M}^2 \cdot \text{K})^{31}$

### Size range

#### Modular dimensions, 1-leaf:

Width: 625 – 1350 mm/1500 mm (XL)  
Height: 1750 – 3000 mm/3500 mm (XL)  
with upper casing (height):  
4000 mm/4500 mm (XL)

#### Modular dimensions, 2-leafs:

Width: 1350 – 3000 mm  
Height: 1750 – 3000 mm/3500 mm (XL)  
with upper casing (height):  
4000 mm/4500 mm (XL)

### Door leaf

- Thick rebate
- 3-leaf rebated
- Door leaf thickness: 62 mm
- Panel thickness: 1.0/1.5 mm (XL: 1.5 mm)

### Surface

Door leaf and frame galvanised and primed; grey white like RAL 9002

### Frame

- Corner frame 1.5 mm thick, galvanised  $\geq 2,500$  mm BRM height = corner frame 2.0 mm thickness)
- With 3-side seal and lower floor bracket
- Frame attached with exposed masonry installation

### Special frame equipment

Counter frame, U frame or block frame

### Glazing

- Glazing field rectangular with Aluminium glass retaining strip
- Round glazing
- Upper casing fully fixed
- Upper casing with glazing or panel filling

### Special equipment

- RAL of your choice
- Handle fittings/profile cylinder
- Anti-panic locks and fixtures
- Door closers
- Arresting systems (with door closer system, adhesive magnet, hinged door drive unit)
- Electrical equipment
- Optional with design profile FB



**Sound-insulated**  
EN ISO 10140/  
EN ISO 717-1  
up to  $R_w$  42 dB<sup>31</sup>



**ATEX**  
Directive  
2014/34/EU<sup>31</sup>



**Use in outdoor walls**  
CE labelling as per  
EN 14351-1

**TECKENTRUP**  
DOOR SOLUTIONS



# STEEL SECURITY DOOR

## "TECKENTRUP" 62 SR3 – LPS 1175

- 1- AND 2-LEAFS
- THIN REBATE
- OPTIONALLY WITH GLAZING AND VENTILATION GRILLES
- ALSO IN STAINLESS STEEL
- FOR INDOOR USE

### Size range

Modular dimension, 1-leaf:

Width: 584 – 1501 mm

Height: 1967 – 4167 mm

Modular dimension, 2-leaves:

Width: 1284 – 4134 mm

Height: 1967 – 4167 mm

With upper casing/top light: 4 600 mm

### Installation in

- Masonry, min. 115 mm
- Concrete, min. 100 mm
- Clad steel and wooden supports F60

### Additional equipment

Fire resistant up to EI<sub>2</sub>60 / E 120

Sound insulation:

- 1-leaf: 42dB max. 1500 x 3000 mm;  
41dB max. 1750 x 3500 mm

Sound insulation:

- 2-leaves: 41db max. 3000 x 3000 mm;  
40dB max. 3750 x 3750 mm

Pressure load:

- up to 7500 Pa max

### Door leaf

- Double-skinned (thin rebate)
- Door 3-leaf rebated
- Door leaf thickness: 62 mm
- Panel thickness: 1.0 mm or 1.5 mm
- Security bolt: per leaf at least 1

### Surface

Door leaf and frame galvanised, powder-coated and primed

### Frame

- Corner frame, 2.0 mm thick
- Door 3-leaf with circumferential seal
- Counter frame attached with exposed masonry installation
- Block frame attached with special SR3 fastenings with M12 VA cylinder head screw

### Special frame equipment

Counter frame, U frame or block frame

### Glazing

- Surelock McGill safety glass (permissible up to fire protection E90)
- Surelock McGill glazing frame (identical to door colour)
- Glazing dimensions: 170x170 mm; 370x170 mm; 670x170 mm
- Ventilation grilles: 400 x 400 mm

### Special equipment

- Installed with SR3 security lock on top (Surelock McGill)
- One point lock (only single leaf )
- Two point lock
- Three point lock
- Five point lock (double panic)
- Top door closer as per EN 1154
- Anti-panic function pursuant to EN179
- Anti-panic function pursuant to EN 1175 (double panic)
- Choice of 108 possible, approved lock combinations



**Fire-resistant**  
as per EN 1634-1  
(DIN 4102)



**Sound-insulated**  
as per EN 20140/  
EN 717-1 up to  
RW 42 dB<sup>1)</sup>

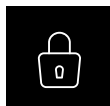

**Burglary-resistant**  
according to LPS  
1175 Issue 7 Security  
Rating 3<sup>1)</sup>

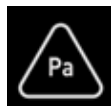

**Pressure resistance**  
as per EN 12210<sup>1)</sup>

**TECKENTRUP**  
DOOR SOLUTIONS



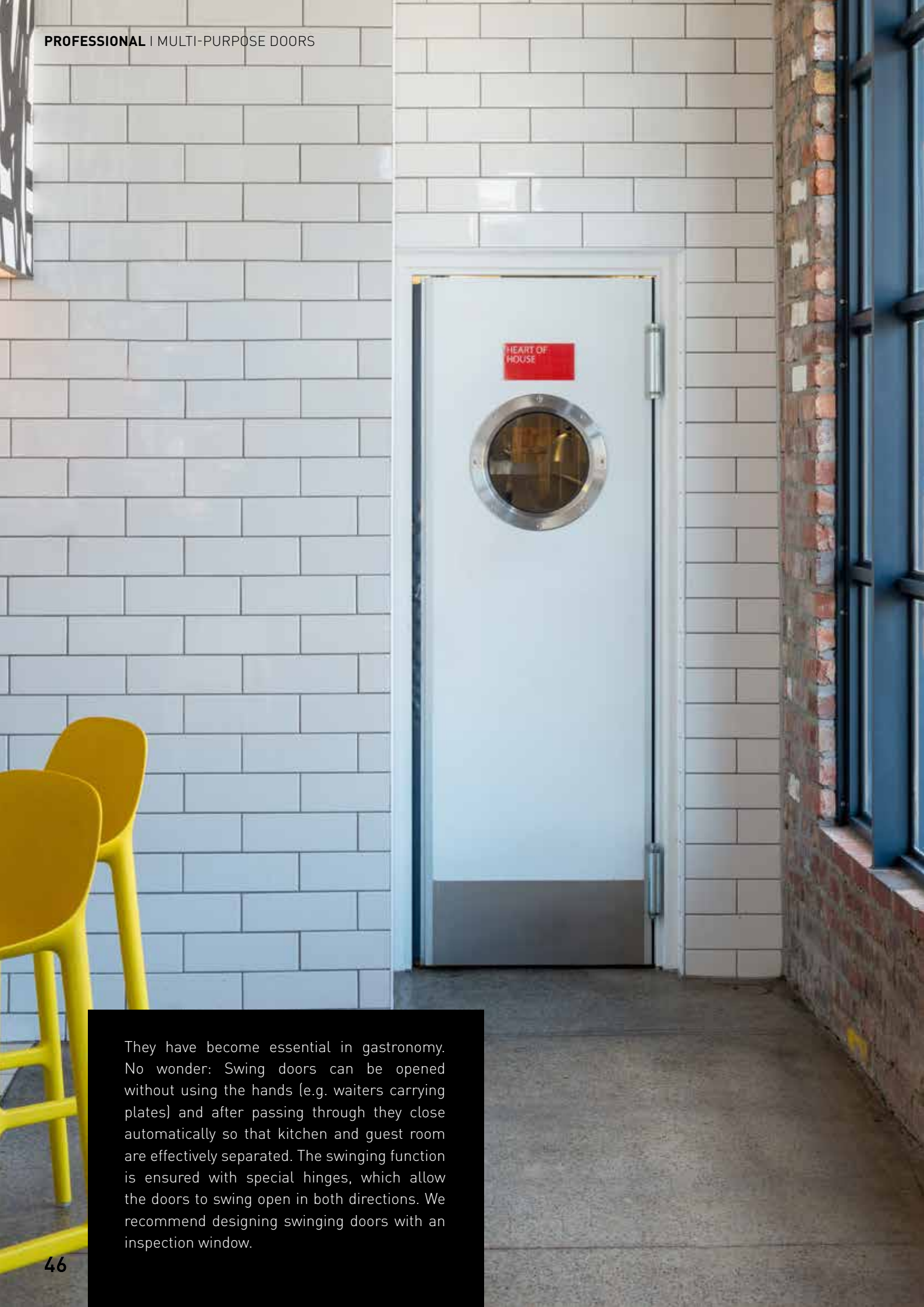

They have become essential in gastronomy. No wonder: Swing doors can be opened without using the hands (e.g. waiters carrying plates) and after passing through they close automatically so that kitchen and guest room are effectively separated. The swinging function is ensured with special hinges, which allow the doors to swing open in both directions. We recommend designing swinging doors with an inspection window.

# STEEL/STAINLESS STEEL DOOR

## TECKENTRUP SWING DOOR

- 1-LEAF OR 2-leafs
- FLUSH-CLOSING
- WITH GLAZING
- ALSO IN STAINLESS STEEL

### Size range

Modular dimensions, 1-leaf:

Width: 750 – 1250 mm

Height: 1875 – 2250 mm

Modular dimensions, 2-leafs:

Width: 1500 – 2500 mm

Height: 1750 – 2500 mm

### Door leaf

- Door leaf thickness: 40 mm
- From hot-tip galvanised fine plate or stainless steel plate V2A 1.4301 240er core polished
- With honeycomb filling
- Swing door hinges, actuating in both directions
- Sealing measures from aluminium special profiles with brushes or EPDM seal

### Surface

Door leaf/frame galvanised and powder-coated, primed, grey white like RAL 9002

### Frame

Corner frame from 2.0 mm galvanised steel plate, made from stainless steel design from 2.0 mm stainless steel plate, V2A 1.4301 240er core polished

### Special frame equipment

Counter frame, U frame or block frame

### Special equipment

- Round glazing
- Light section
- Stainless steel push handle (both sides)
- Drive bar
- Fuhr lockable





# STAINLESS STEEL DOOR

## TECKENTRUP WATER-1/2 DF

- 1-LEAF OR 2-leafs
- THICK REBATE
- IN STAINLESS STEEL
- FOR INDOORS AND OUTDOORS

### Size range

Modular dimensions, 1-leaf:

Width: 750 – 1250 mm  
Height: 1750 – 2500 mm

Modular dimensions, 2-leafs:

Width: 1375 – 2500 mm  
Height: 1750 – 2500 mm

### Door leaf

- Thick rebate
- 3-leaf rebated
- Door leaf thickness: 52 mm
- Panel thickness: 1.0 mm
- Insulation with water-repellent insulant

### Surface

Stainless steel V2A 1.4301 door leaf:  
240er core polished  
Frame: 240er core polished

### Frame

- Corner frame 1.5 mm thick
- With 3-side seal and lower floor bracket made from stainless steel
- Frame attached with exposed masonry installation

### Special frame equipment

Counter frame, U frame or block frame

### Special equipment

- Round glazing
- Light section
- Preparation for rosette fixture
- Top door closer



Use in outdoor walls  
CE labelling as per  
EN 14351-1





# THE INHABITANTS - TECKENTRUP INTERNAL DOORS



**Interior design stepchild or representative design element? In the interior area, doors make manifold contributions to the overall effect of the ambience.**

Be it the residential area, offices, storage or hobby rooms, washing or drying rooms: Teckentrup offers the right solution for all requirements. For instance, the range of surface designs reaches from galvanised to colour and patterns all the way to wooden décor.

All internal doors can be provided with glazing as requested. The standard furnishings of internal doors include a round level handle set made of black plastic. In addition, additional furnishings made of coloured plastic, aluminium or stainless steel are offered. By the way: Teckentrup internal doors can be installed easily into existing standard frames. Accordingly, we offer a separate door leaf that can be hung up or a complete, ready-to-install door element with standard corner frame, as needed.

## **Uses**

- All other industrial areas
- Commercial premises
- Offices
- Communal rooms
- Residential housing





# STEEL INTERNAL DOOR

## “TECKENTRUP” DF

- 1-LEAF OR 2-leafs
- THICK REBATE
- WITH HONEYCOMB FILLING
- ALSO WITH GLAZING AND IN STAINLESS STEEL

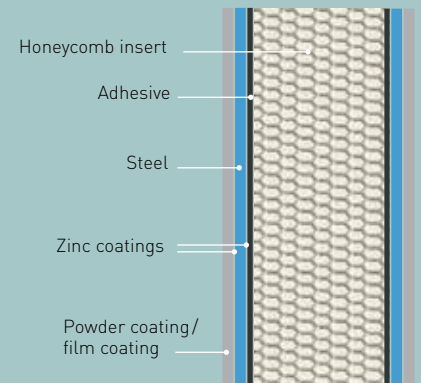

### Size range

Modular dimensions, 1-leaf:

Width: 625 – 1250 mm

Height: 1875 – 2250 mm

Modular dimensions, 2-leafs:

Width: 1500 – 2500 mm

Height: 1875 – 2250 mm

### Door leaf

- 40 mm thick, 3-side rebated made from hot-tip galvanised fine sheet (honeycomb filling)
- Design of door leaf made from stainless steel plate from 240-er core with protection film, frame made from 1.5 mm stainless steel plate
- Strain group S (only 1-leaf)
- Climate class III (only 1-leaf)

### Surface

- Galvanised and primed (powder-coated) traffic white like RAL 9016)
- Galvanised and powder-coated in the colours: Pure white, sepia brown, carmine red, moose green, reed green, dove blue

### Frame

- Element corner frame, hinges V8026/hunch hinge), galvanised
- Powder-coated traffic white RAL 9016
- With 3-side circumferential seal
- Welded wall dowel anchors

### Special frame equipment

Corner frame, U frame, block frame  
Corner and counter frame

### Glass strip design/glazing

- E6-anodised LM strips (nature anodised)
- Wire ornamental glass up to 6 mm

### Special equipment

- RAL of your choice
- Round glazing
- Stainless steel version
- Door leaf without frame
- Bathroom lock / toilet lock
- Spyhole
- Mail slot
- Ventilation grille
- Top door closer
- Anti-panic lock
- With slide threshold, frame with raised sill
- Floor seal, retractable





# STEEL INTERNAL DOOR

## “OBJECT” DF

- 1-LEAF OR 2-leafs
- THICK REBATE
- WITH TUBULAR CHIPBOARD INSERT
- ALSO WITH GLAZING

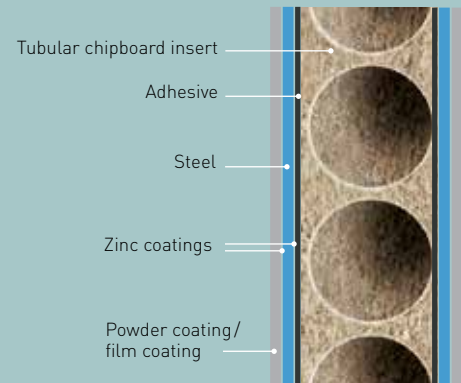

### Size range

Modular dimensions, 1-leaf:

Width: 625 – 1250 mm

Height: 1875 – 2250 mm

Modular dimensions, 2-leafs:

Width: 1500 – 2500 mm

Height: 1875 – 2250 mm

### Door leaf

- 40 mm thick, 3-side rebated made from hot-tip galvanised fine sheet
- Tubular chipboard insert with door panels fully glued
- Slave sash: Aluminium buffer profile with 2 flush-bolts
- Strain group S (only 1-leaf)
- Climate class III (only 1-leaf)

### Surface

- Galvanised
- Galvanised and primed (powder-coated) traffic white like RAL 9016)
- Galvanised and powder-coated in the colours: Pure white, sepia brown, carmine red, moose green, reed green, dove blue
- Galvanised and plastic-film-coated in the decorations: Oak bright, ash white, beech nature, oak classic and cherry

### Frame

- Element corner frame, hinges V8026/ hunch hinge), galvanised
- Powder-coated traffic white RAL 9016
- With 3-side circumferential seal
- Welded wall dowel anchors

### Special frame equipment

Corner frame, U frame, block frame  
Corner and counter frame

### Glass strip design/glazing

- E6-anodised LM strips(nature anodised)
- Wire ornamental glass up to 6 mm

### Special equipment

- RAL of your choice
- Round glazing
- Door leaf without frame
- Bathroom lock / toilet lock
- Spyhole
- Mail slot
- Ventilation grille
- Top door closer
- Anti-panic lock
- With slide threshold, frame with raised sill
- Floor seal, retractable





# GREAT DESIGN APPEARANCE

A wide variety of colours and surfaces, hinges, door handles, and glazing variants provide ample leeway for the visual design. Choose from large selection of door handles that match the overall concept. Together with our 3D hinges, the flushness of the cable channels, the concealed frame, and the stainless steel material, the result is as aesthetically pleasing overall impression that appears to have come from a mould.

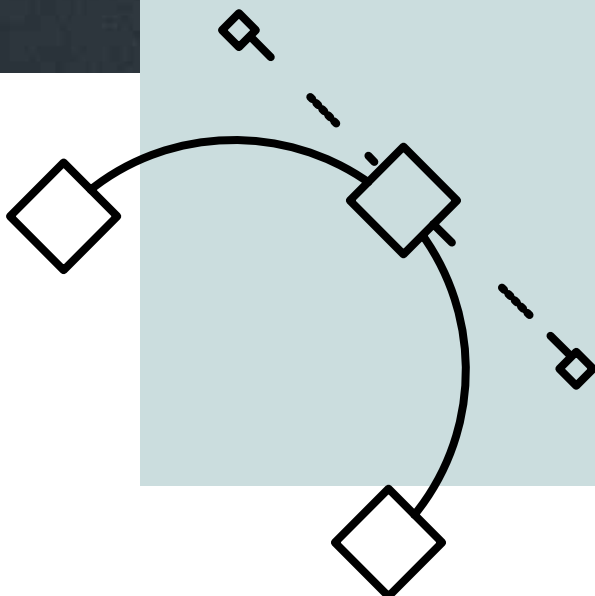



# ALWAYS MATCHES YOUR TASTE

Teckentrup fire and smoke protection doors are delivered with a primer coating in grey-white, similar to RAL 9002. Optional are powder end coatings in accordance with RAL colour map.

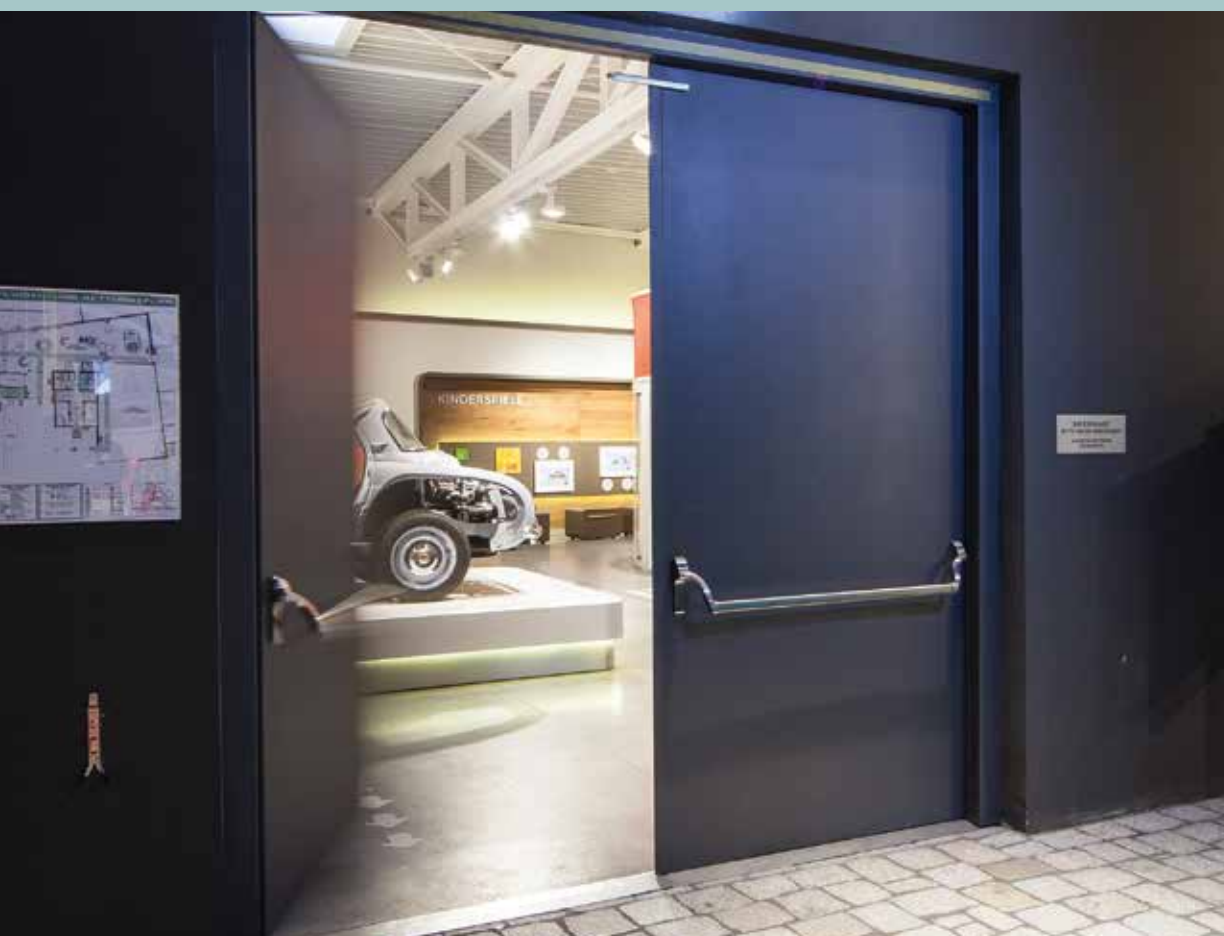



## GLAZING OPTIONS FOR BRIGHT MOMENTS

Depending on approvals, the application and function, doors can be provided with glazing in various shapes, glass qualities and frame materials. Additional shapes and arrangements available per the valid price list or upon request.



Glazing with steel frame, optionally in stainless steel



Glazing with aluminium frame



Glazing with aluminium frame with stainless steel appearance



Round glazing in stainless steel

Rechteck 1

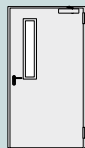

Rechteck 2

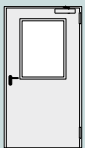
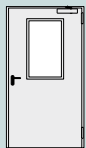
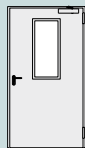
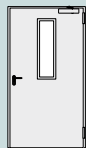

Rechteck 3

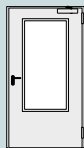
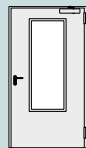
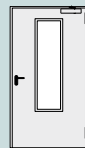
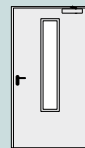

Rechteck 4



Lichte Durchsicht

Alu-Glashalteleisten =

120x800

190x800

315x800

440x800

565x800

190x1260

315x1260

440x1260

565x1260

545x345

Stahl-Glashalteleisten =

140x820

210x820

335x820

460x820

585x820

210x1280

335x1280

460x1280

585x1280

-

(RC 3 / RC 4)

Rund

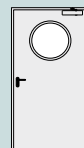
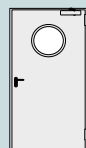

Lichte Durchsicht

Stahl-Glashalteleisten =

Ø 300

Ø 400

Ø 500

Rechteck nach Wahl

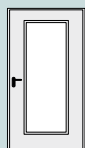

bis 2m<sup>2</sup>

Sonderverglasungen

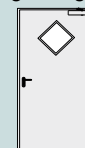
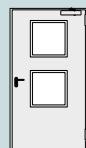



## STAINLESS STEEL



### SPECIAL ACCENT WITH STAINLESS STEEL

Stainless steel doors are especially dazzling. The representative patterns, matching lever handle sets and hinges create a modern, aesthetic room design. Stainless steel doors are also used in areas with special hygienic requirements.



Stainless steel,  
polished  
(240er core)

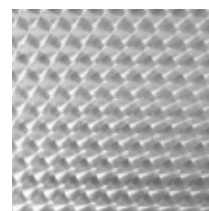

Stainless steel,  
circle-polished  
(marbled)

# DOOR HANDLE

Attractive lever/lever and lever/knob handle sets made of plastic, aluminium, and stainless steel meet all requirements of function and ergonomics. Here you can find a selection of the available handle sets.

**Lever/lever and lever/knob handle sets and change sets** in short and long plate versions



**Round handle set, short plate,**  
aluminium



**Round lever/knob handle set, short plate,**  
aluminium



**Round handle set, short plate,**  
aluminium



**Round handle set, long plate,**  
aluminium

**Lever and lever/knob handle set** with escutcheon



**Round handle set, escutcheon,**  
aluminium



**Round lever/knob handle set, escutcheon,**  
aluminium



**Round handle set, escutcheon,**  
stainless steel



**Round lever/knob handle set, escutcheon,**  
stainless steel

**ES 1 security handle sets for RC2 doors or ES 3 for RC3 and RC4 doors in accordance with EN 1627**



**Security lever handle set Class ES 1 per DIN 18257,**  
aluminium



**Security lever/knob handle set Class ES 1 per DIN 18257,**  
aluminium



**Security lever/knob handle set Class ES 3 per DIN 18257,**  
aluminium



## Flush styling with the Teckentrup design profile FB.

Flush doors with harmonious lines, aesthetic recess and harmonious closing edges are features of contemporary architecture. The trend towards a reduction of visible structures through to puristic solutions as well as a formal integration of technical and functional elements has asserted itself in many areas in recent years.

Wish and reality collide on the building site. Cumbersome detailed solutions can quickly consume a lot of time and money and result in an execution risk. When developing our solution, we always also consider a simple installation in addition to the architectural quality and ease of use.

With the Teckentrup design profile FB, we have developed a simple solution for flush styling. We now thereby enable simple installation of doors with contemporary and aesthetic styling.



### Strong design

- Flush front
- Attractive and contemporary
- Frame profile in mitre
- Design stainless steel fittings



### Strong security

- Anti-burglary protection up to RC 4 possible
- High quality
- Stable construction for high demands



### Strong service

- Short delivery times
- Quick installation on the building site



### For every purpose

- Construction
- Contemporary industrial architecture
- Offices
- Healthcare or education
- Hotels
- Public buildings
- Server rooms
- Nurseries

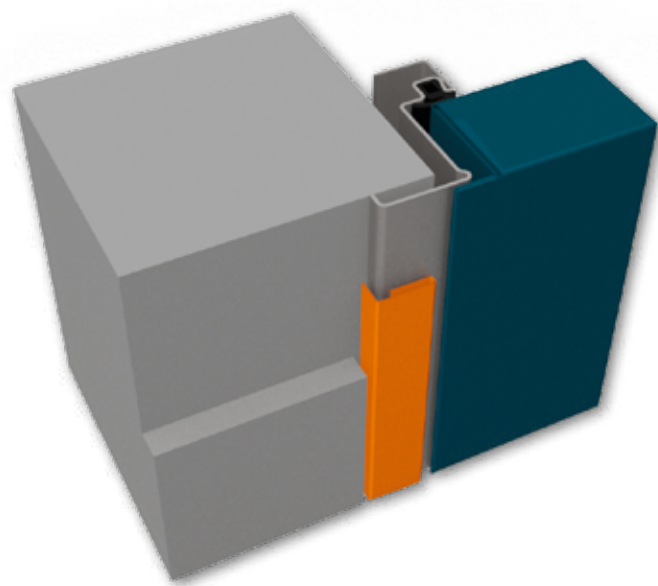

The frame set can be easily combined with standard frames. In combination with a block frame, the door is flush with the wall, as a supplement to corner or closed frames, the door leaf is flush in the frame and on one level with the skirting board. The wide variability of the available door variants is also ensured with the design profile FB: They are available with many additional functions: smoke protection, sound insulation, anti-burglary protection, glazing - the doors can be adapted to almost any structural and planning specification.



Frame mitre



Aesthetic appearance

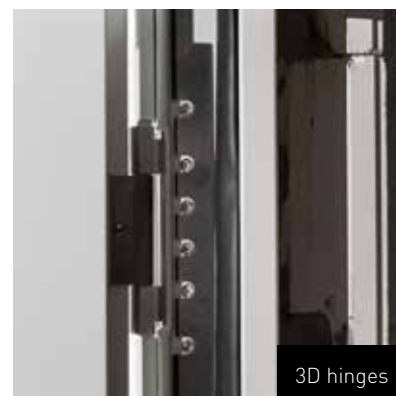

3D hinges

#### \* Available for:

##### Thin rebate doors<sup>1)</sup>

T30/T90, multipurpose, RC2-RC4, sound insulation up to 42dB, smoke protection

##### Thick rebate doors<sup>1) 2)</sup>

T30, multipurpose, RC2-RC3, sound insulation up to 42dB, smoke protection

1) Excluded: Stainless steel doors, upper casing 2) Opening angle reduced to 160°

# GREATEST SAFETY FOR MANY APPLICATIONS

The numerous safety functions of project doors are guaranteed with various door closers, arresting devices, drives, anti-panic equipment, etc. The door leaf and frame provide the basis for a long-lasting door element. However, it is only complete with high-quality fittings and electrical equipment which implement current requirements on reliable function with an integrated system.

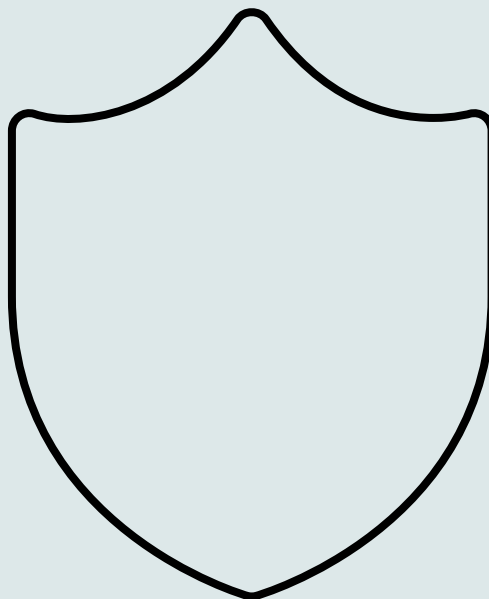





# LAYER FOR LAYER QUALITY

Safety, durability, aesthetics – the same requirements also apply for the surfaces of our products\*.

- a** Internal core depending on application
- b** 2-component industrial adhesive
- c** Anti-corrosion galvanisation
- d** High-strength steel
- e** Anti-corrosion galvanisation
- f** Door leaf and frame primer similar to RAL 9002
- g** Powder-coating finish (optional)





## PANIC LOCK

Automatically locking  
anti-panic lock with  
A panic bar handle  
in accordance with DIN 1125,

In the case of an emergency, users must be able to exit the building as quickly as possible. Therefore, it must always be possible to open doors in escape routes. On request, we equip our project doors with locks and fittings for emergency exits in accordance with DIN EN 179 or for escape routes in accordance with DIN EN 1125. Therefore, a safe exit is always guaranteed - even if the doors are locked. Here, panic handle and push bar provide the safest solution because they unlock automatically when physical pressure is applied to the door.

## LOCK AND ESCAPE ROUTE TECHNOLOGY

Our locks and locking systems will impress you with the highest level of quality and permanent reliability.



Automatically locking anti-panic locks can also be equipped with multi-point locks.



Push bar: It enables the opening of the door by gently pushing on the release surface.



Standard lock: Mortice lock with knob, perforated profile. Alternatively, other locks such as an additional bolt switching lock or motor lock can also be used.

## HINGES AND SECURITY BOLTS

Our doors receive sturdy construction hinges with ball bearings. Flush-closing doors can also be equipped with the completely concealed Tectus hinge system on request.



**3D hinge - refinement and functionality:** For improved installation friendliness, we offer flexible 3D hinges for our project doors. They are an innovation which enables subsequent adjustment of the door leaf in 3 directions. This enables problem-free compensation of small tolerances. The 3D hinges are available in galvanised and stainless steel versions.



**Construction hinge:** Construction hinges with ball bearings guarantee that opening and closing the door will always be easy. The hinges are integrated in the door leaf and thus have no influence on the visual appearance of the door leaf surface. The door height can be subsequently adjusted with the supplied hinge hook rings up to 4 mm.



**Security bolts:** When the door is closed, they protrude into the frame and provide additional protection against forced entry.

## ELECTRICAL ATTACHMENTS

Doors with electrical systems are frequently interconnected. This includes escape routes and alarm technology as well as motor and block locks, for example. The overall look of our building doors is not affected by the concealed cable conduit.



**Concealed cable access:** Doors with electrical systems are frequently interconnected. This includes escape routes and alarm technology as well as motor locks, for example. The overall look of our building doors is not affected by the concealed cable conduit.



**Electric strikes / Door drive:** The door opener can be used to access the building remotely (2-leaves doors also). Swing door drives provide added comfort and ease of operation, e.g. in hospitals, retirement homes, etc.



**Concealed magnetic contact:** With its concealed installation in the frame and door leaf, the magnetic contact reports when the door is closed and/or open.



**Escape door terminal:** Safely locked in everyday use while allowing quick and easy opening in the case of an emergency. These are the most important requirements for doors in escape and emergency routes. Electronic escape route securing systems assist in fulfilling these apparently contradictory requirements.



## DOOR CLOSERS

Door closers ensure the automatic closing of doors. They are also available with arresting systems or free-wheel function.



## INTEGRATED DOOR CLOSERS

A must for aesthetics A door closer which is completely integrated in the door leaf and thus becomes invisible when the door is closed. Integrated door closers compliment the concealed Tectus hinges.

## TRANSFORMER GRILLE

Transformers require a room closure with a transformer grille. They can be integrated in the robust design of our multi-purpose doors or as separate elements in the building. Depending on the optical requirement, we offer the grilles in aluminium, steel and stainless steel.



Multi-purpose door with transformer grille

## VENTILATION GRILLE

Ventilation grilles are used when rooms have to be ventilated, for instance because no other option via windows or supply air exists. Ventilation grilles are possible in the stainless steel or aluminium designs.



Multi-purpose door with ventilation grille

# DESIGN PROFILE FB

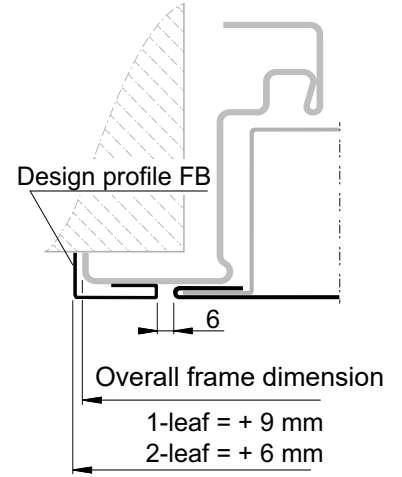
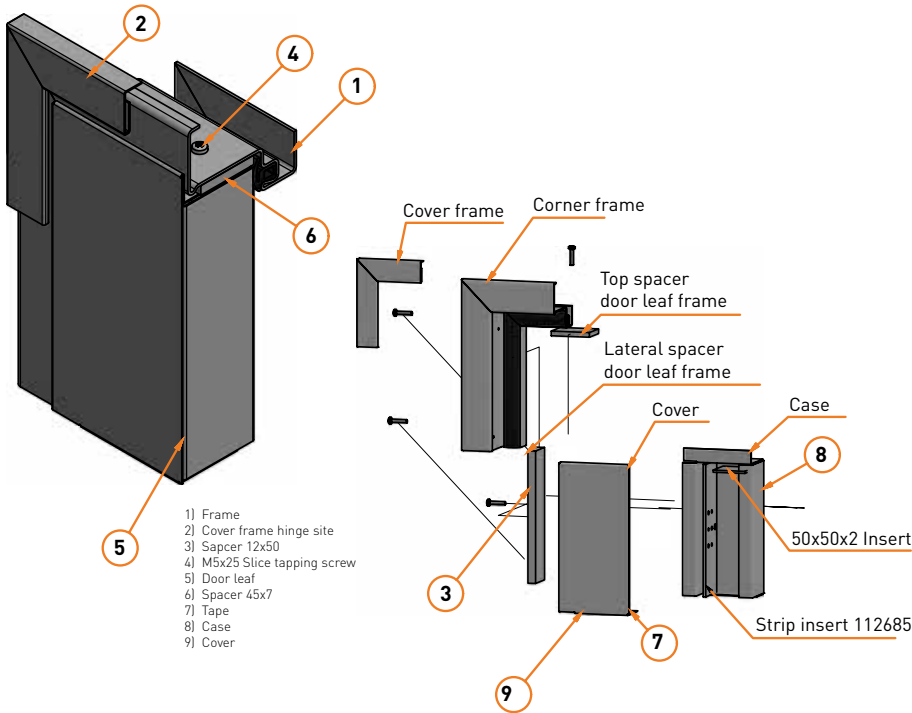

**Installation in:**

- Masonry
- Concrete
- Autoclaved aerated concrete
- Lightweight construction stud wall only with block frame 4.1 (with T30, multipurpose)

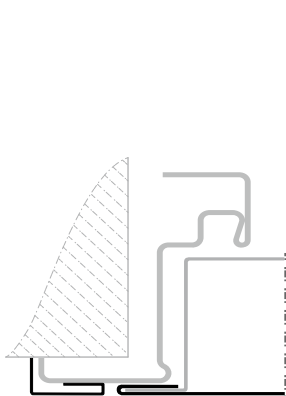

**Corner Frame**  
 (Thin/Thick rebate door)

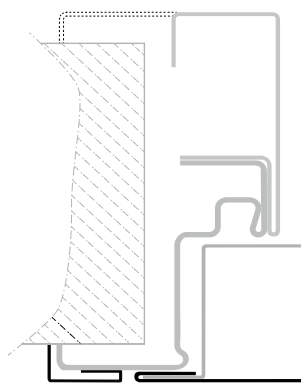

**Corner/Counter frame**  
 (Thin/Thick rebate door)

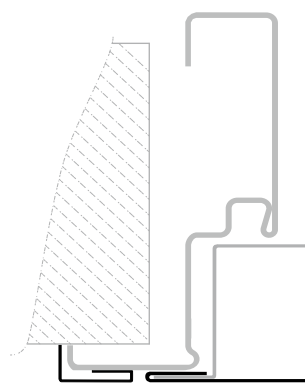

**Closed frame**  
 (Thin/Thick rebate door)

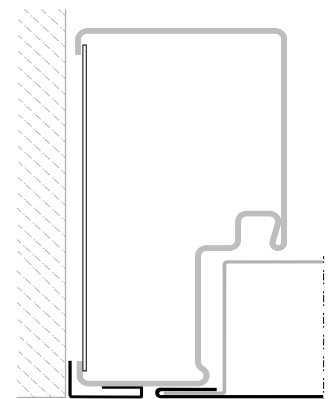

**Block frame Typ 4.1**  
 (Thin/Thick rebate door)

# NEW FRAME FASTENING FOR LIGHTWEIGHT CONSTRUCTION STUD WALLS



Without new frame fastening



With new frame fastening

## Advantages:

- Aesthetic design thanks to invisible screw connections in the front and rear frame part
- Invisible fastening for construction hinges, almost no longer visible with 3D hinges
- Installation up to 20% faster

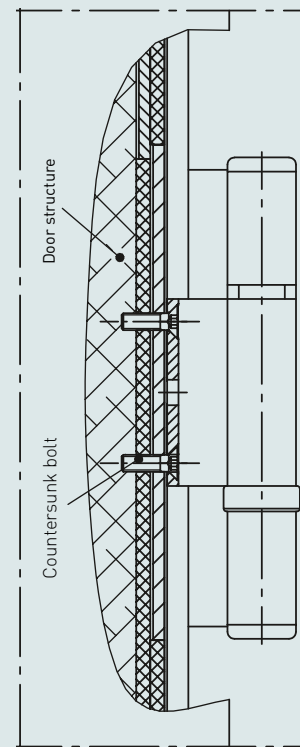
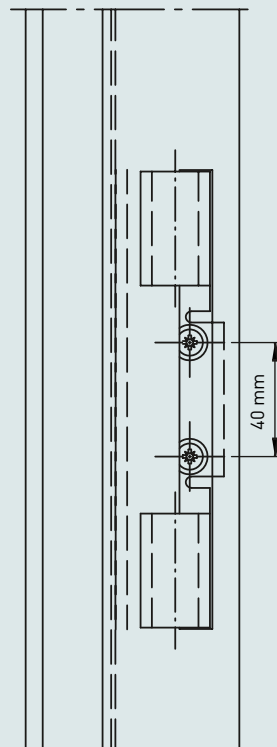
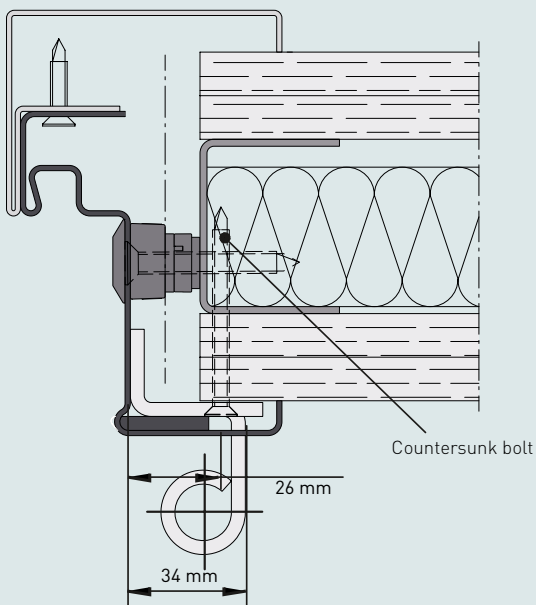

# CORNER FRAME

Corner frame for 62er doors, wall plug assembly

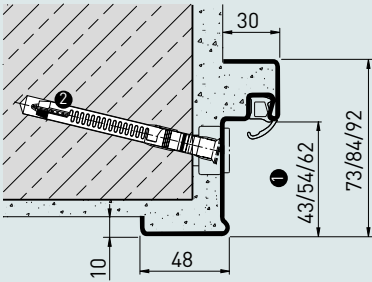

1. Depends on door leaf thickness and rebate construction
2. Installation with frame anchor possible (excluded T60, T90)

Quick and concealed installation with adjustable screws and only one fastening point.



Corner frame for 42 mm doors, wall plug assembly (masonry/concrete)

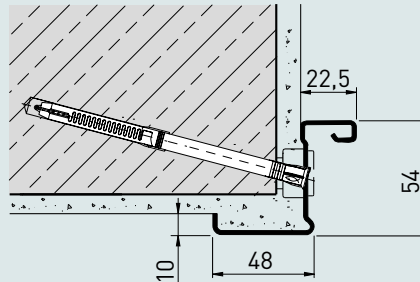

Wall anchor, dowelled, (masonry/concrete)

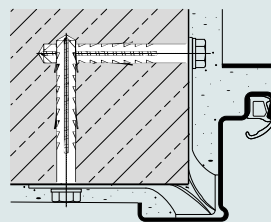

Wall anchor, mortared, (masonry/concrete)

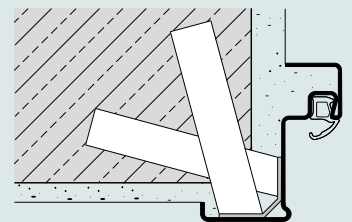

Weld installation with sliding anchor (exposed masonry)

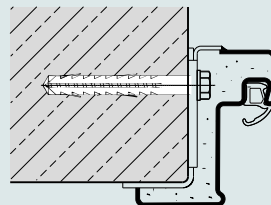

Wall plug installation (aerated concrete)

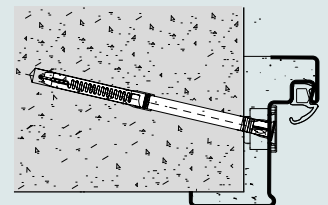



## TSM CORNER FRAME - DRY, QUICK ASSEMBLY

- MORTAR-FREE FRAME FASTENING
- READY-TO-ASSEMBLE SYSTEM
- OPTIONALLY ALSO IN REVEAL DEPTH



Mortar-free wall plug assembly  
(masonry/concrete)

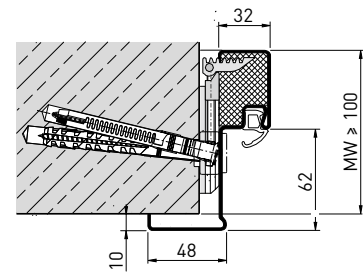

- Frame factory infill with mineral wool
- No time-consuming grouting - no mess
- Complete installation in one step
- Simple fixing of the frame with a special frame anchor
- Improvement of the overall appearance with concealed fastening
- Ready-to-install frame also suitable for retroactive installation in a finished wall

# CORNER/COUNTER FRAME

Corner/counter frame for 62 mm doors  
Wall plug installation with slide anchor  
(masonry/concrete)

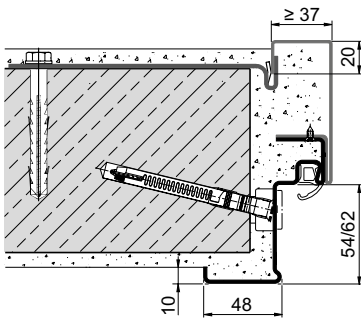

Depends on door leaf thickness and rebate construction

Corner/counter frame for 42 mm doors  
Wall plug installation with slide anchor  
(masonry/concrete)

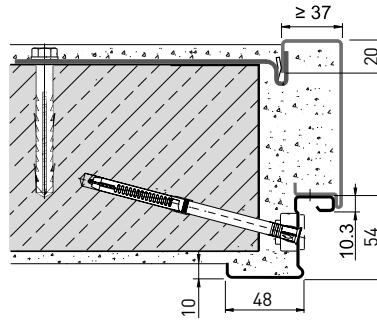

Wall plug and hinged anchor installation (masonry/concrete)

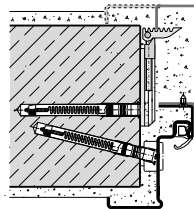

Weld installation with anchor bracket (autoclaved aerated concrete walls)

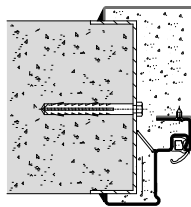

Wall anchor, dowelled with slide anchors  
(masonry/concrete)

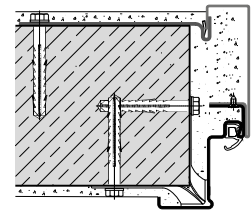

Wall plug and hinged anchor installation (exposed masonry/autoclaved aerated concrete walls)

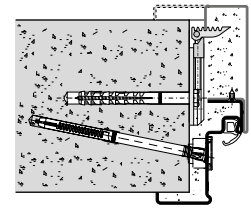

Countersunk screw fastening (lightweight partition)

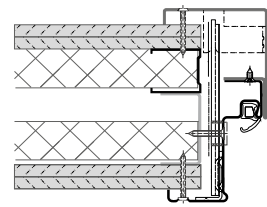

Concealed installation of the counter frame with special fold anchor



# CIRCUMFERENTIAL FRAME

Wall plug with slide anchor  
(masonry / concrete)

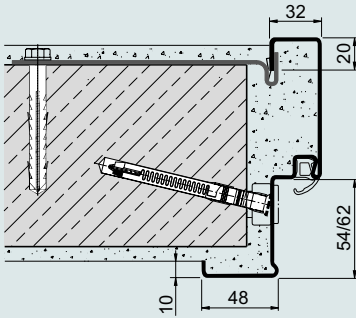

Depends on door leaf thickness and rebate construction

Quick and concealed installation of the closed frame using adjusting screws and slide anchors.



Wall anchor, dowelled with slide anchors (masonry/ concrete)

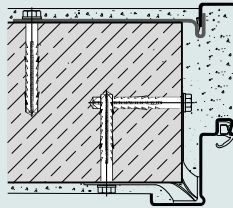

Wall plug and hinged anchor installation (exposed masonry/autoclaved aerated concrete walls)

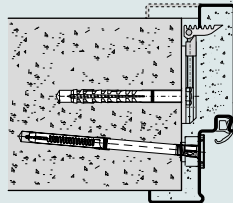

Countersunk screw attachment (lightweight construction stud wall)

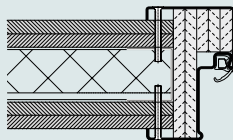

Wall plug and hinged anchor installation (masonry/concrete)

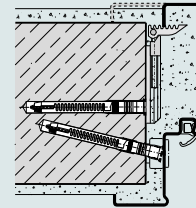

Weld installation with anchor bracket (autoclaved aerated concrete walls)

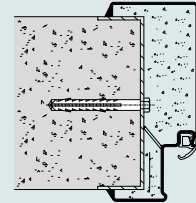

# BLOCK FRAME

Type 4.1 Wall plug assembly with plaster filling (masonry/autoclaved aerated concrete)

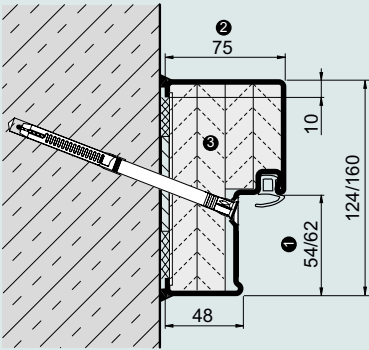

1. Depends on door leaf thickness and rebate construction
2. For block frame Type 4.2 = 100 mm
3. Factory infill optional

Quick and easy installation of a block frame Type 4.1 with factory infill



Type 2.2 Concealed wall plug assembly in front of opening (masonry/concrete),

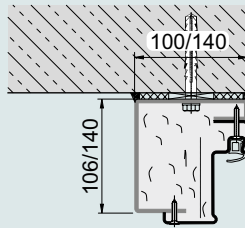

On-site screw-mounting and optional factory infill

Type 2.3 Concealed wall plug assembly in opening (masonry/autoclaved aerated concrete)

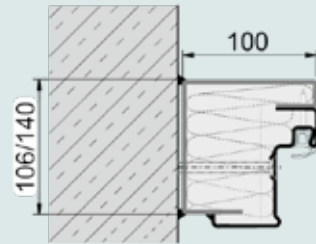

Factory pre-installed and optional factory infill

Type 5.1 Wall plug assembly in front of opening (masonry/concrete),

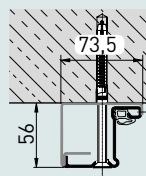

Type 5.3 / 5.3 L Wall plug assembly in the opening (masonry/concrete/steel beams)

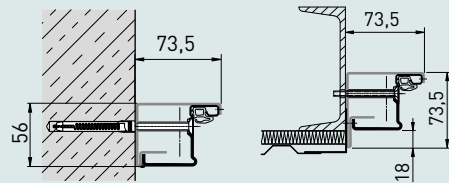

Version for single- and double-leaf Multi-purpose doors Teckentrup dw 42-1/2, optional factory infill

# BOTTOM SEAL

## Sliding threshold

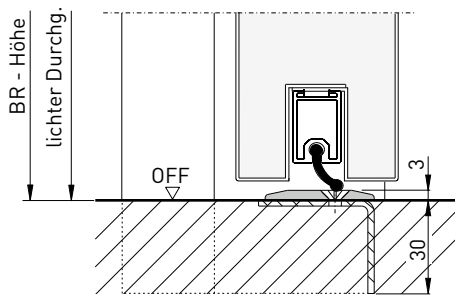

## Buffer seal

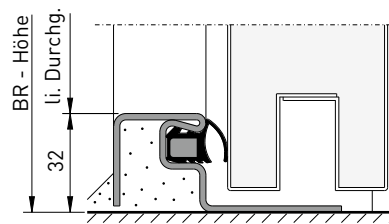

## Retractable bottom seal

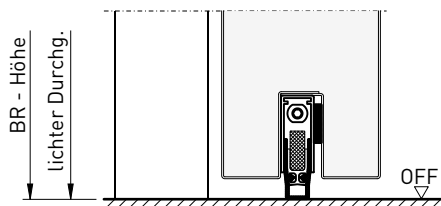

## Double retractable bottom sea (for highly sound-insulated doors)

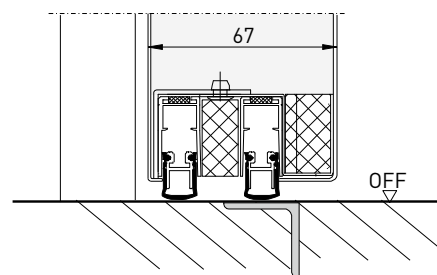

## Double sliding threshold and bottom profile (for high sound-insulated doors)

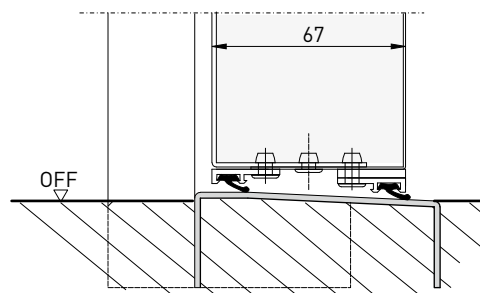

## Time delayed retractable bottom sea

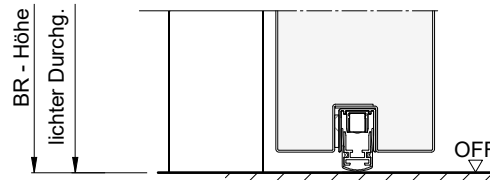



**PROFESSIONAL | DATA SHEET**

Main qualification		burglary-resistant						bullet-proof	prison cell		sound-insulated			multi-purpose		
DOOR NAME	dw 42-1	dw 62-1/2 (thin rebate)		dw 62-1/2 (thick rebate)		dw 64-1 BP	Type A/B	Type B + T15	dw 67-1/S	dw 67-1/2 HS		dw 62-1 iso+	MZD-HT 8			
Number of leaves	1-leaf	1-leaf	1-leaf	2-leafs	2-leafs	1-leaf	2-leafs	1-leaf	1-leaf	1-leaf	1-leaf	1-leaf	2-leafs	1-leaf	1-leaf	
Product on pages	16	18	18	18	18	20	20	22	24	24	28	30	30	34	36	
<b>ADDITIONAL QUALIFICATIONS, STANDARD</b>																
Heat insulation	1.6	1.3	-	1.4	-	1.3	1.4	-	-	-	-	-	-	0,89	1,5	
<b>ADDITIONAL QUALIFICATIONS WITH APPROPRIATE EQUIPMENT</b>																
Fire protection	-	-	-	-	-	-	-	■	■	■	-	-	-	-	-	
Smoke protection	-	-	-	-	-	-	-	-	-	-	-	-	-	-	-	
Sound insulation (dB)	37	35-42	-	37-42	-	38-42	38-42	45	-	-	50-53	55-57	55	38	37-39	
Anti-burglary characteristics	WK 2	RC 2-3	RC 4	RC 2-3	RC 4	RC 2-3	RC 2-3	RC 4	RC 3/4	RC 4	RC 2	RC 2	-	RC 2	-	
Outdoor use	■	■	■	■	■	■	■	-	-	-	-	-	-	■	■	
ATEX	-	■	■	■	■	■	■	■	-	-	■	■	■	■	-	
Pressure resistance (on request)	-	■	■	■	■	-	-	-	-	-	-	-	-	-	-	
<b>DOOR LEAF</b>																
Leaf thickness (mm)	42	62	62	62	62	62	62	64	64	64	67	67	67	62	42	
Panel thickness (mm)	primed	1.0/1.5	1.0/1.5	1.0/1.5	1.0/1.5	1.0/1.5	1.0/1.5	1.5	1.5/2.0	1.5/2.0	1.5	1.5	1.5	1.0	0.9	
	Stainless steel	-	■	■	-	-	-	-	-	-	-	-	-	-	-	
Rebate	Thin rebate	■	■	■	■	■	-	■	■	■	-	-	-	-	■	
	Thick rebate	-	-	-	-	-	■	■	-	-	■	■	■	-	-	
	flush	-	-	-	-	-	-	-	-	-	-	-	-	-	-	
Glazing possible	-	■	■	■	■	■	■	■	■	■	-	-	-	-	■	
Upper casing/top light possible	-	-	-	-	-	-	-	-	-	-	-	-	-	-	-	
<b>FRAME VARIANTS</b>																
Corner frame	■	■	■	■	■	■	■	■	■	■	■	■	■	■	■	
Counter frame	■	■	■	■	■	■	■	■	■	■	■	■	■	■	■	
Closed frame	■	■	■	■	■	■	■	■	■	■	■	■	■	-	-	
Block frame	■	■	■	■	■	■	■	-	■	■	-	-	-	-	-	
<b>INSTALLATION IN</b>																
Masonry	■	■	■	■	■	■	■	■	■	■	■	■	■	■	■	
Concrete	■	■	■	■	■	■	■	■	■	■	■	■	■	■	■	
Aerated concrete	■	■	■	■	■	■	■	-	-	-	-	-	-	■	■	
Lightweight partition	-	■	■	■	■	■	■	-	-	-	-	-	-	■	■	
<b>BASIC DIMENSION (MM)</b>																
Width	minimum	625	500	500	1375	1375	500	1375	750	750	750	750	750	1375	625	750
	maximum	1250	1500	1500	3000	3000	1500	3000	1500	1500	1250	1500	1500	3000	1250	1125
Height	minimum	1750	500	500	1750	1750	500	1750	1750	1750	1750	1750	1750	1750	1750	1750
	maximum	2250	3000	3000	3000	3000	3000	3000	3000	2500	2250	3000	3000	3000	2350	2125
Max. total height with upper casing	-	-	-	-	-	-	-	-	-	-	-	-	-	-	-	

												internal doors			
dw 42-1/2		dw 62-1/2 / ("XL") (thin rebate)		dw 62-1/2 / ("XL") (thick rebate)		SR3 - LPS 1175		Swing door		Water-1/2		Teckentrup		Object	
1-leaf	2-leafs	1-leaf	2-leafs	1-leaf	2-leafs	1-leaf	2-leafs	1-leaf	2-leafs	1-leaf	2-leafs	1-leaf	2-leafs	1-leaf	2-leafs
38	38	40	40	42	42	44	44	46	46	48	48	52	52	54	54
1.6	1.8	1.3/(-)	1.4/(-)	1.3/(-)	1.4/(-)	-	-	-	-	-	-	-	-	-	-
-	-	-	-	-	-	■	■	-	-	-	-	-	-	-	-
-	-	-	-	-	-	-	-	-	-	-	-	-	-	-	-
37	37	37-42*	37-42*	38-42	38-42	42	41	-	-	-	-	-	-	-	-
-	-	-	-	-	-	SR3	SR3	-	-	-	-	-	-	-	-
■	■	■	■	■	■	-	-	-	-	■	■	-	-	-	-
-	-	■	■	■	■	-	-	-	-	-	-	-	-	-	-
-	-	-	-	■	■	■	■	-	-	-	-	-	-	-	-
42	42	62	62	62	62	62	62	40	40	52	52	40	40	40	40
1.0/1.5	1.0/1.5			1.0/1.5	1.0/1.5	1.5	1.5	1.0	1.0	-	-	0.5	0.5	0.5	0.5
-	-	1.0	1.0	1.0	1.0	1.0	1.0	1.0	1.0	1.0	1.0	0.8	-	-	-
■	■	■	■	-	-	■	■	-	-	-	-	-	-	-	-
■	■	-	-	■	■	-	-	-	-	■	■	■	■	■	■
-	-	-	-	-	-	-	-	-	-	-	-	-	-	-	-
■	■	■	■	■	■	■	■	-	-	■	■	■	■	■	■
■	■	■	■	■	■	-	-	-	-	-	-	-	-	-	-
■	■	■	■	■	■	■	■	On demand	■	■	■	■	■	■	■
■	■	■	■	■	■	■	■		■	■	-	-	-	-	-
■	■	■	■	■	■	-	-		■	■	■	■	■	■	■
■	■	■	■	■	■	■	■		■	■	■	■	■	-	■
■	■	■	■	■	■	■	■	■	■	■	■	■	■	■	■
■	■	■	■	■	■	■	■	■	■	■	■	■	■	■	■
■	■	■	■	■	■	-	-	■	■	■	■	■	■	■	■
■	■	■	■	■	■	■	■	■	■	■	■	■	■	■	■
625	1375	625	1375	625	1375	584	1284	750	1500	750	1375	625	1500	625	1500
1250	2500	1350 (1500)	3000	1350 (1500)	3000	1501	4134	1250	2500	1250	2500	1250	2500	1250	2500
1750	1750	1750 (3001)	1750 (3001)	1750 (3001)	1750 (3001)	1967	1967	1875	1750	1750	1750	1875	1875	1875	1875
2250	2250	3000 (4000)	3000 (4000)	3000 (3500)	3000 (3500)	4167	4167	2250	2500	2500	2500	2250	2250	2250	2250
3250	3250	5000	5000	4500	4500	-	-	-	-	-	-	-	-	-	-

\* dw 62-1/2 (thin rebate) = sound insulation with glazing



DESIGN | SECURITY | SERVICE

Professional solutions

We provide customised solutions for your individual requirements. With our security, sound protection, multi-purpose and internal doors, you can count on more design, security and service.

[WWW.TECKENTRUP.BIZ](http://WWW.TECKENTRUP.BIZ)

We are happy to help.